

- ▼ Low Gate Charge
- ▼ Fast Switching Characteristic
- ▼ Simple Drive Requirement
- ▼ RoHS Compliant & Halogen-Free

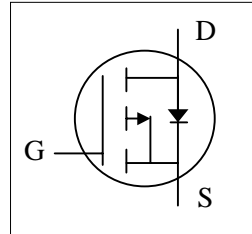

$BV_{DSS}$	-30V
$R_{DS(ON)}$	50m $\Omega$
$I_D$	- 4.1A

## Description

XP3P050A series are innovated design and silicon process technology to achieve the lowest possible on-resistance and fast switching performance. It provides the designer with an extreme efficient device for use in a wide range of power applications.

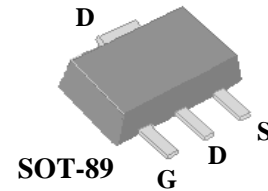

## Absolute Maximum Ratings @ $T_j=25^\circ\text{C}$ (unless otherwise specified)

Symbol	Parameter	Rating	Units
$V_{DS}$	Drain-Source Voltage	- 30	V
$V_{GS}$	Gate-Source Voltage	$\pm 20$	V
$I_D @ T_A=25^\circ\text{C}$	Drain Current, $V_{GS} @ 10V^3$	- 4.1	A
$I_D @ T_A=70^\circ\text{C}$	Drain Current, $V_{GS} @ 10V^3$	-3.2	A
$I_{DM}$	Pulsed Drain Current <sup>1</sup>	-20	A
$P_D @ T_A=25^\circ\text{C}$	Total Power Dissipation	1.25	W
$T_{STG}$	Storage Temperature Range	-55 to 150	$^\circ\text{C}$
$T_J$	Operating Junction Temperature Range	-55 to 150	$^\circ\text{C}$

## Thermal Data

Symbol	Parameter	Value	Unit
Rthj-a	Maximum Thermal Resistance, Junction-ambient <sup>3</sup>	100	$^\circ\text{C}/\text{W}$

**Electrical Characteristics @ $T_j=25^{\circ}\text{C}$  (unless otherwise specified)**

Symbol	Parameter	Test Conditions	Min.	Typ.	Max.	Units
$BV_{DSS}$	Drain-Source Breakdown Voltage	$V_{GS}=0V, I_D=-250\mu A$	-30	-	-	V
$R_{DS(ON)}$	Static Drain-Source On-Resistance <sup>2</sup>	$V_{GS}=-10V, I_D=-4A$	-	-	50	m $\Omega$
		$V_{GS}=-4.5V, I_D=-2A$	-	-	75	m $\Omega$
$V_{GS(th)}$	Gate Threshold Voltage	$V_{DS}=V_{GS}, I_D=-250\mu A$	-1	-	-3	V
$g_{fs}$	Forward Transconductance <sup>2</sup>	$V_{DS}=-10V, I_D=-4A$	-	8	-	S
$I_{DSS}$	Drain-Source Leakage Current	$V_{DS}=-24V, V_{GS}=0V$	-	-	-10	$\mu A$
$I_{GSS}$	Gate-Source Leakage	$V_{GS}=\pm 20V, V_{DS}=0V$	-	-	$\pm 0.1$	$\mu A$
$Q_g$	Total Gate Charge	$I_D=-2A$	-	6.5	10.4	nC
$Q_{gs}$	Gate-Source Charge	$V_{DS}=-15V$	-	1.5	-	nC
$Q_{gd}$	Gate-Drain ("Miller") Charge	$V_{GS}=-4.5V$	-	2.5	-	nC
$t_{d(on)}$	Turn-on Delay Time	$V_{DS}=-15V$	-	8	-	ns
$t_r$	Rise Time	$I_D=-1A$	-	7	-	ns
$t_{d(off)}$	Turn-off Delay Time	$R_G=3.3\Omega$	-	25	-	ns
$t_f$	Fall Time	$V_{GS}=-10V$	-	10	-	ns
$C_{iss}$	Input Capacitance	$V_{GS}=0V$	-	600	960	pF
$C_{oss}$	Output Capacitance	$V_{DS}=-15V$	-	100	-	pF
$C_{rss}$	Reverse Transfer Capacitance	$f=1.0\text{MHz}$	-	70	-	pF
$R_g$	Gate Resistance	$f=1.0\text{MHz}$	-	13	26	$\Omega$

**Source-Drain Diode**

Symbol	Parameter	Test Conditions	Min.	Typ.	Max.	Units
$V_{SD}$	Forward On Voltage <sup>2</sup>	$I_S=-1A, V_{GS}=0V$	-	-	-1.2	V
$t_{rr}$	Reverse Recovery Time	$I_S=-2A, V_{GS}=0V$	-	14	-	ns
$Q_{rr}$	Reverse Recovery Charge	$di/dt=-100A/\mu s$	-	5	-	nC

**Notes:**

1. Pulse width limited by Max junction temperature.
2. Pulse test
3. Surface mount on FR4 board,  $t \leq 10s$ .

THIS PRODUCT IS SENSITIVE TO ELECTROSTATIC DISCHARGE, PLEASE HANDLE WITH CAUTION.

USE OF THIS PRODUCT AS A CRITICAL COMPONENT IN LIFE SUPPORT, AUTOMOTIVE OR OTHER SIMILAR SYSTEMS IS NOT AUTHORIZED.

XSEMI DOES NOT ASSUME ANY LIABILITY ARISING OUT OF THE APPLICATION OR USE OF ANY PRODUCT OR CIRCUIT DESCRIBED HEREIN; NEITHER DOES IT CONVEY ANY LICENSE UNDER ITS PATENT RIGHTS, NOR THE RIGHTS OF OTHERS.

XSEMI RESERVES THE RIGHT TO MAKE CHANGES WITHOUT FURTHER NOTICE TO ANY PRODUCTS HEREIN TO IMPROVE RELIABILITY, FUNCTION OR DESIGN.

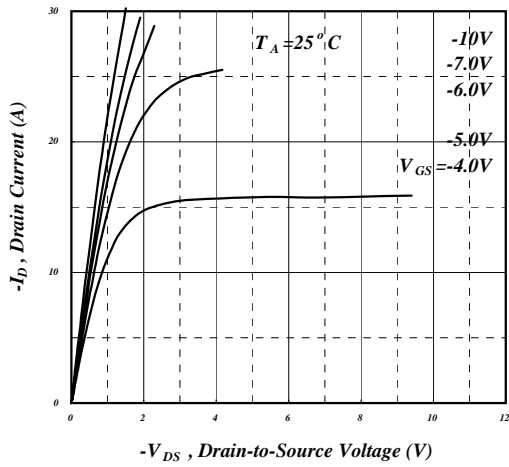

**Fig 1. Typical Output Characteristics**

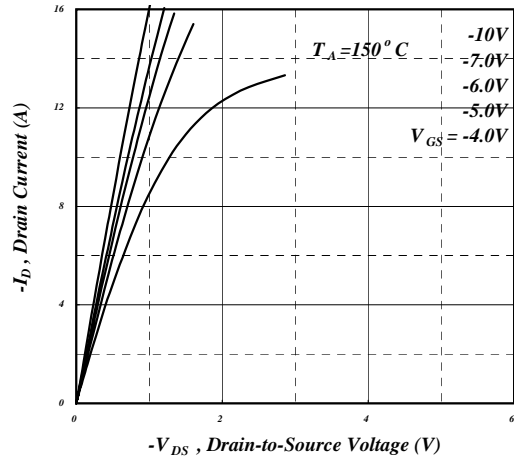

**Fig 2. Typical Output Characteristics**

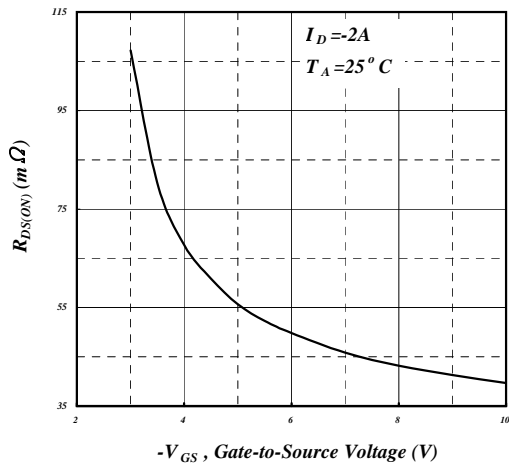

**Fig 3. On-Resistance v.s. Gate Voltage**

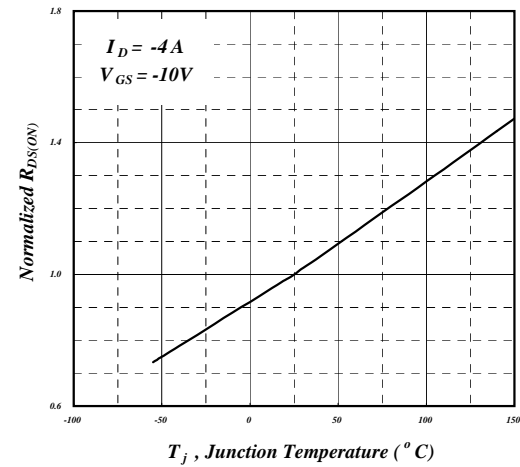

**Fig 4. Normalized On-Resistance v.s. Junction Temperature**

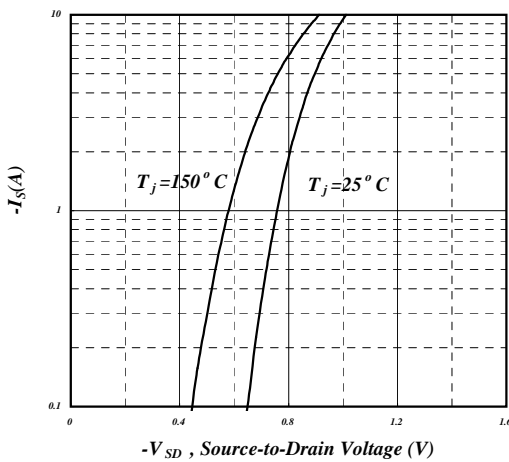

**Fig5. Forward Characteristic of Reverse Diode**

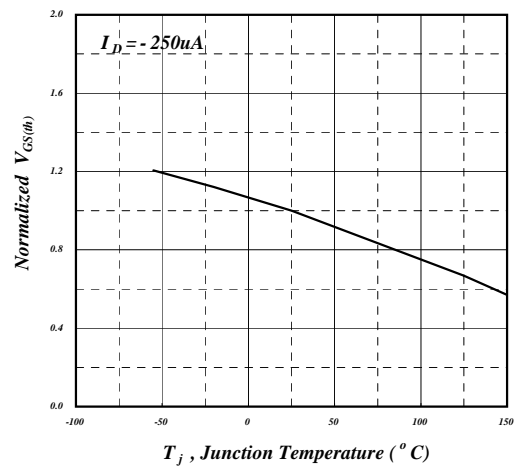

**Fig 6. Gate Threshold Voltage v.s. Junction Temperature**

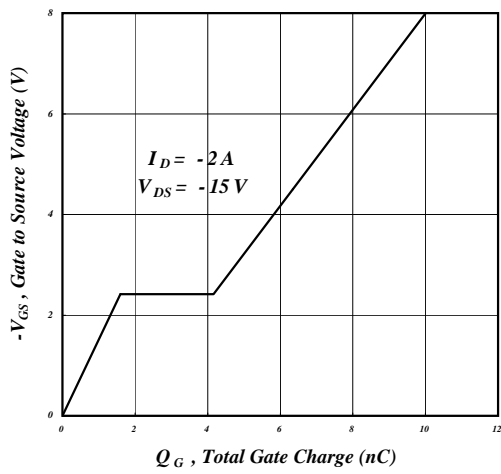

**Fig 7. Gate Charge Characteristics**

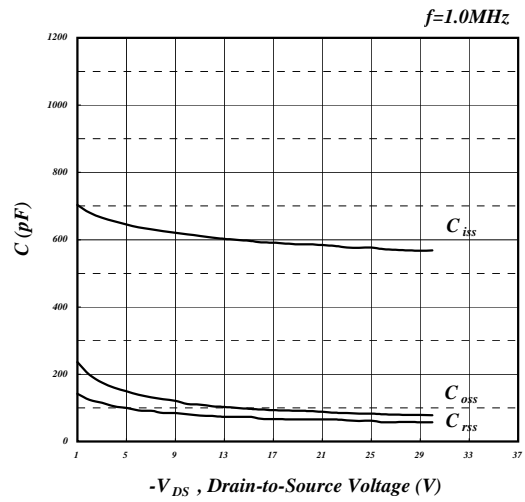

**Fig 8. Typical Capacitance Characteristics**

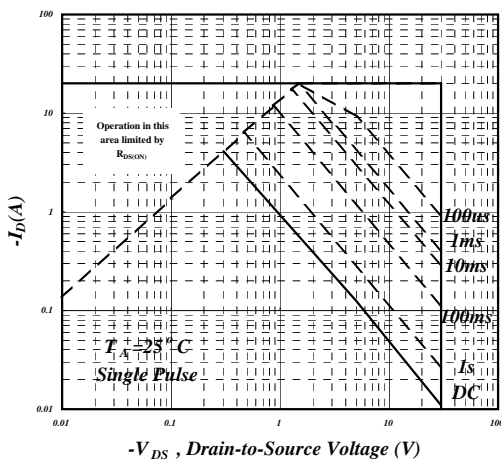

**Fig 9. Maximum Safe Operating Area**

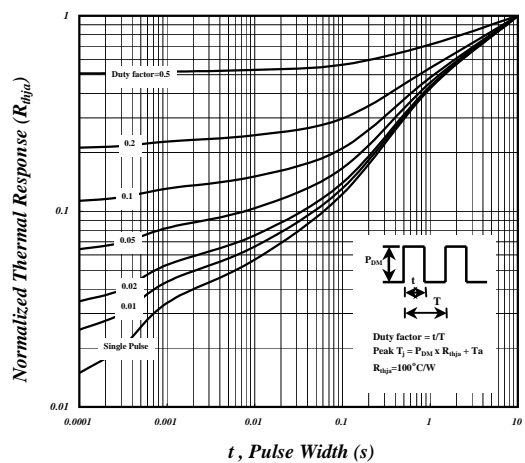

**Fig 10. Effective Transient Thermal Impedance**

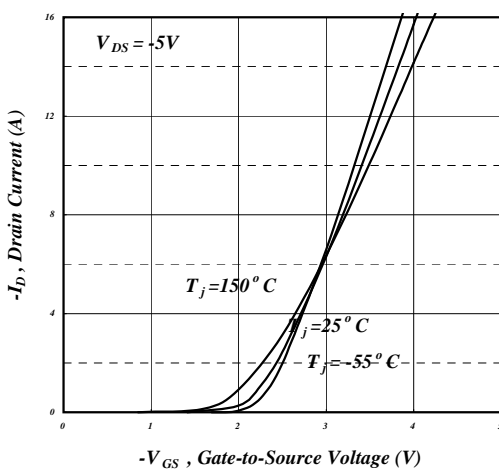

**Fig 11. Transfer Characteristics**

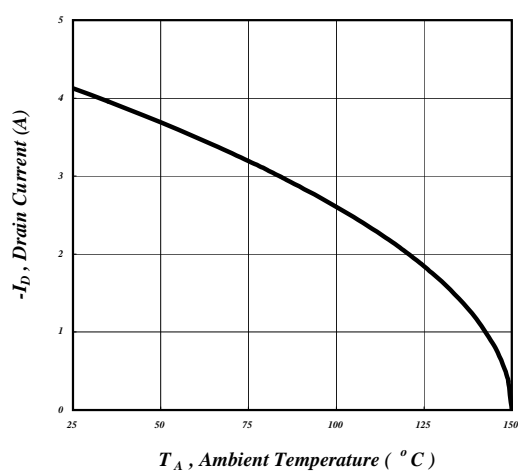

**Fig 12. Drain Current v.s. Ambient Temperature**

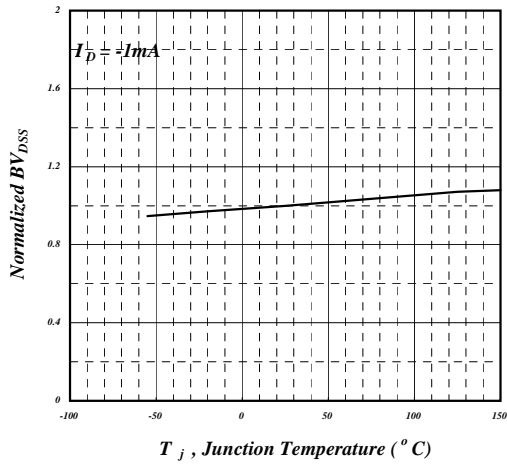

**Fig 13. Normalized  $BV_{DSS}$  v.s. Junction Temperature**

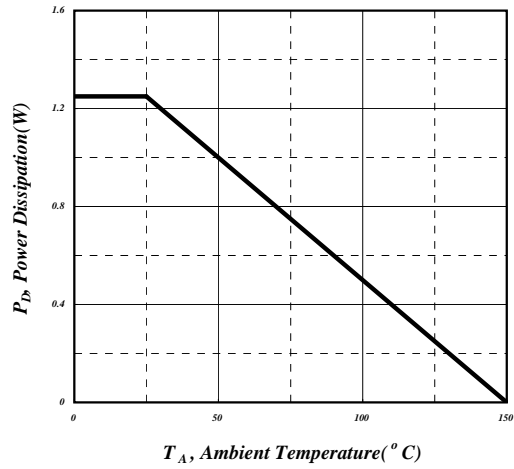

**Fig 14. Total Power Dissipation**

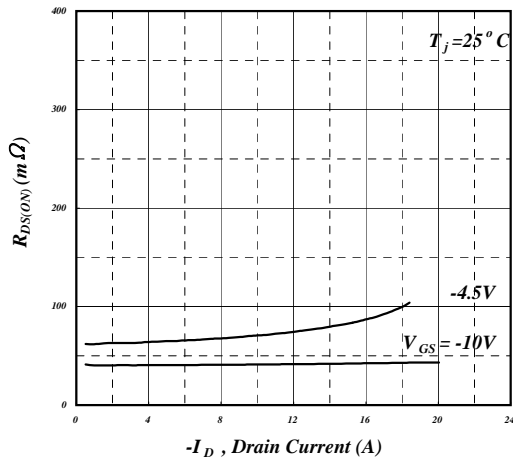

**Fig 15. Typ. Drain-Source on State Resistance**

---

**MARKING INFORMATION**

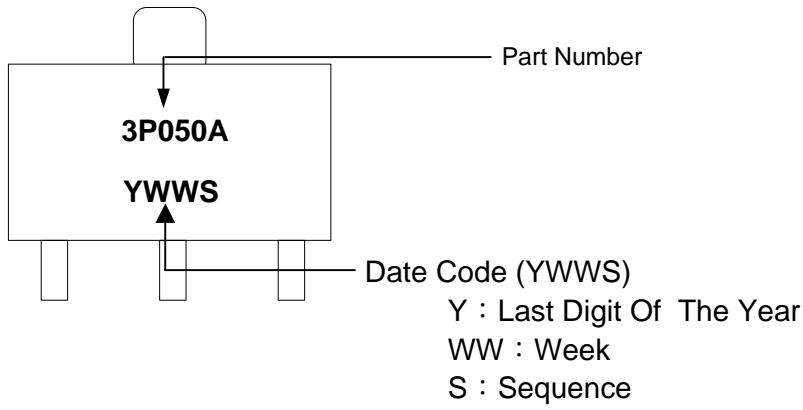

**Package Outline & Packing : SOT-89-5L**

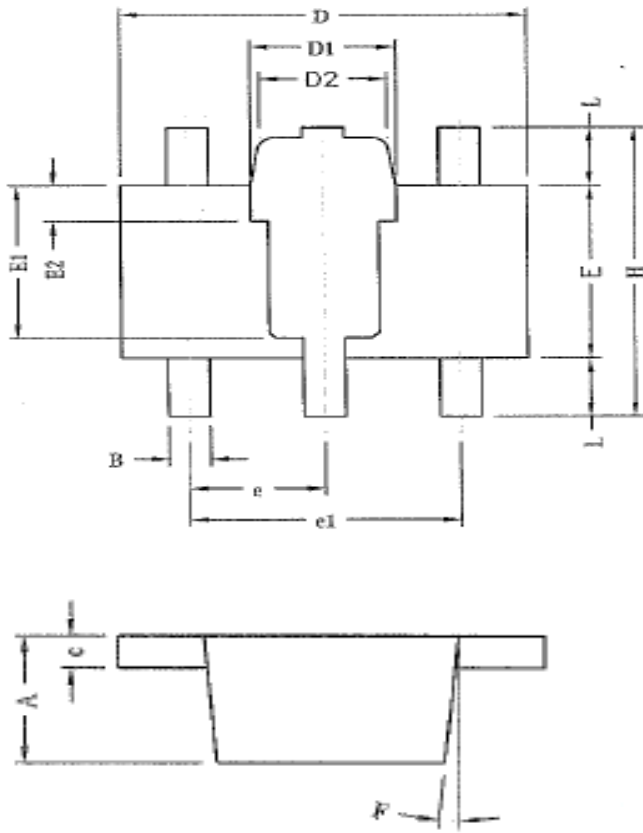

SYMBOLS	Millimeters		
	MIN	NOM	MAX
A	1.40	1.50	1.60
B	0.50	0.51	0.52
c	0.35	0.38	0.41
D	4.40	4.50	4.60
D1	1.50	1.60	1.70
D2	1.30	1.40	1.50
E	2.40	2.50	2.60
E1	2.2 REF		
E2	0.52 REF		
e	1.50 REF		
e1	3.00 REF		
F	5° REF		
H	4.05	4.15	4.25
L	0.8	—	

- 1.All Dimensions Are in Millimeters.
- 2.Dimension Does Not Include Mold Protrusions.

**SOT-89-5L FOOTPRINT :**

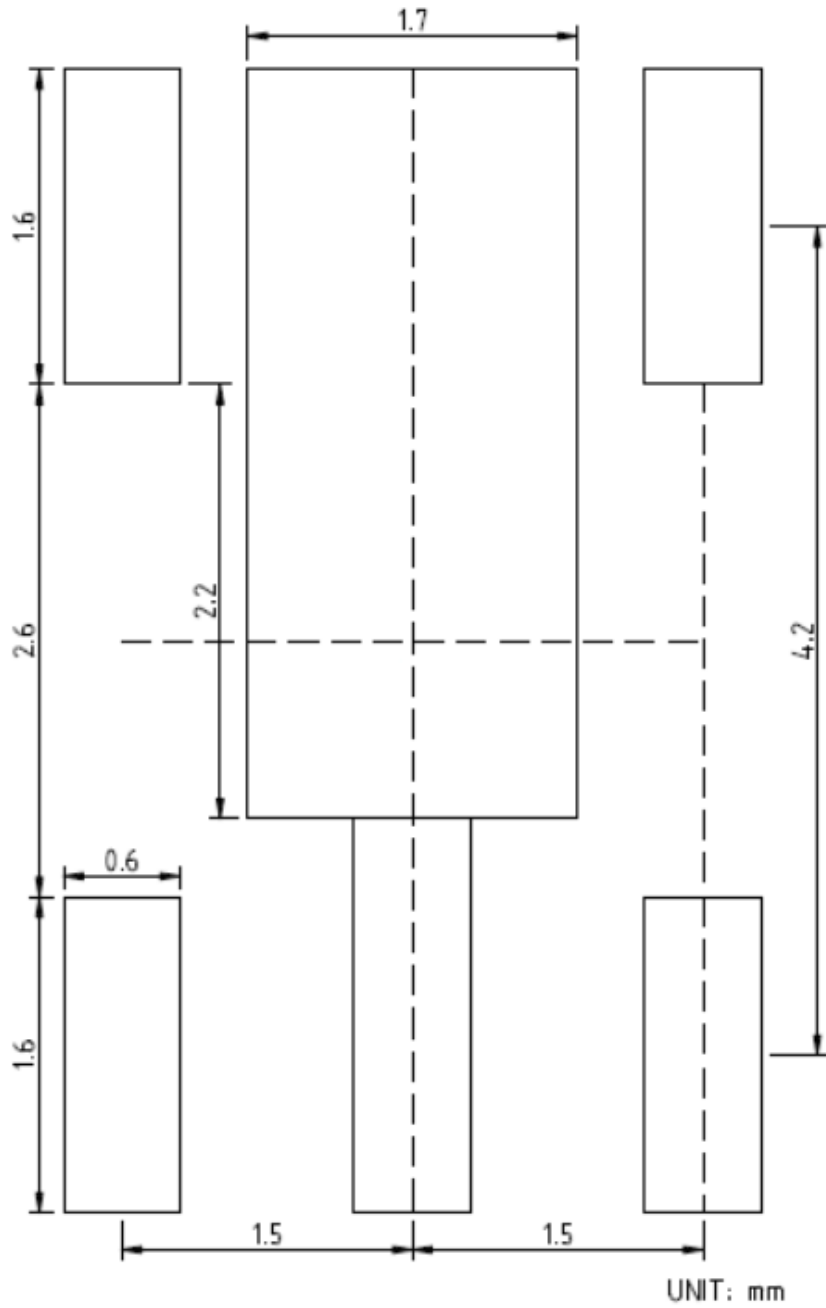



**Package Outline & Packing : SOT-89-5L**

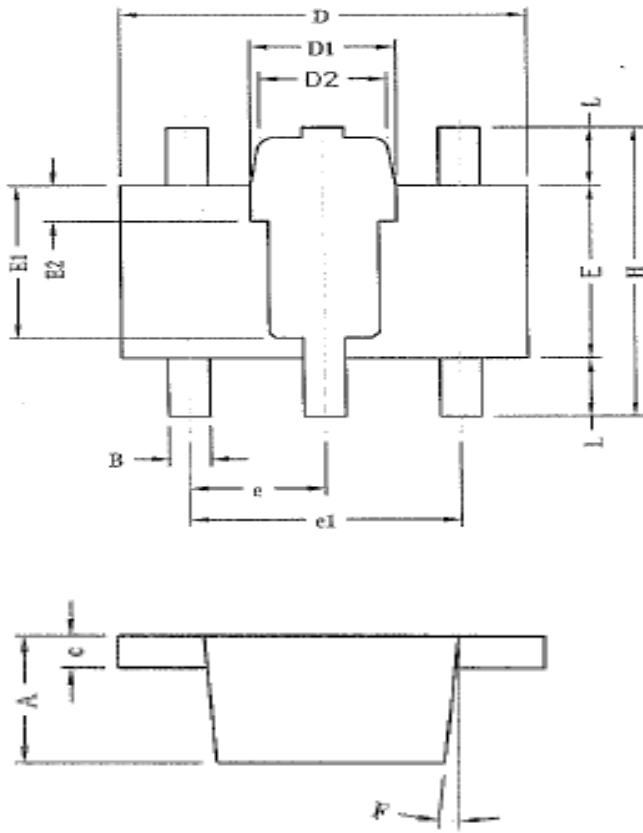

SYMBOLS	Millimeters		
	MIN	NOM	MAX
A	1.40	1.50	1.60
B	0.50	0.51	0.52
c	0.35	0.38	0.41
D	4.40	4.50	4.60
D1	1.50	1.60	1.70
D2	1.30	1.40	1.50
E	2.40	2.50	2.60
E1	2.2 REF		
E2	0.52 REF		
e	1.50 REF		
e1	3.00 REF		
F	5° REF		
H	4.05	4.15	4.25
L	0.8	—	

- 1.All Dimensions Are in Millimeters.
- 2.Dimension Does Not Include Mold Protrusions.

**SOT-89-5L FOOTPRINT :**

